



Ocean Sensor Systems, Inc.

Sonic Wave Sensor RV, OSSI-010-036

Ultrasonic Wave Sensor with Analog 5 Volts,
Serial RS232 or RS485 & Synchronized Sampling

General Description:

The OSSI-010-036 Sonic Wave Sensor RV is a water level sensor that combines a rugged IP67 resistant to water submersion package, low power microprocessor and Anti-aliasing sensing circuit. The Sonic Wave Sensor RV has a range of 2.5 meters. See Sheet 2 Wave Performance for limitations. It is powered with any external voltage from 4.5 volts to 45 volts. There are 3 versions with different signal outputs. The OSSI-010-036-1 has a RS485 output and a 0-5V analog output. The OSSI-010-036-2 has a RS232 output and a 0-5V analog output. The OSSI-010-036-3 has a RS485 output. Laptops and PCs can easily receive the Sonic Wave Sensor RV's data using the RS232 or RS485 to USB Adaptors that are supplied. Time stamped data can be used to synchronize up to 8 Sonic Wave Sensor RVs. The Staff & Sonic Product Interface Program is available to download from our web site to configure, display, analyze and store the sensor data.

Features

- RS232 or RS485 and 0 to 5V analog outputs
- USB to RS232 or RS485 Adapter supplied
- 8 Sonic Wave Sensor RV's per RS485 Network
- Measure Submillimeter Waves.
- Powered with voltages from 4.5V to 45V
- Automatic Anti-aliasing filter
- Sample Rates: 1, 2, 4, 8, 16 & 32
- Continuous Sampling or Burst Mode
- Data output Continuous or Buffered
- Data format: ASCII, Binary Float or Binary Integer
- Configurable Start Time
- Time Tagged Data
- Real Time Clock Auto Synchronizing
- Supply Voltage Monitoring
- 0.25% FS Accuracy 0-100% range
- Optional 0.1% FS Accuracy 0-100% range
- Automatic Calibration

Sonic Wave Sensor RV



Sonic & Staff Products Interface Program



Wave Performance:

The Range chart below is divided into 5 arbitrary zones for convenience. The performance is a gradual change over the full range.

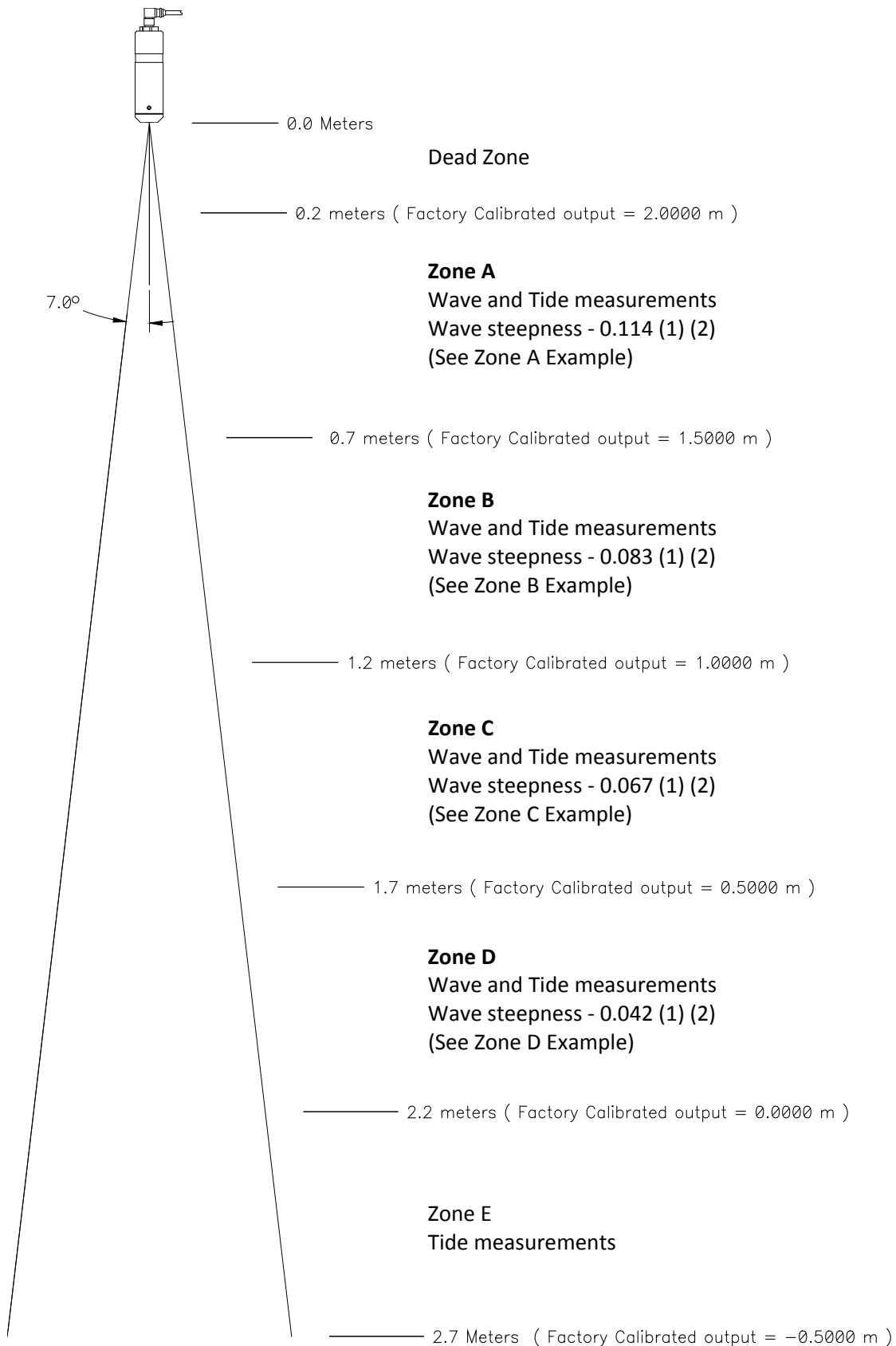

Notes:

(1) Wave Steepness is the ratio of wave height divided by wave length (Steepness = H/L).

(2) Wave steepness greater than the listed value per zone will cause some lost samples during the steepest portion of the wave. During this time the Sonic Wave Sensor will report the last valid value until the next valid sample is read.

Zone A - Example: (zoom in to view details)

Zone A: Fast Submillimeter wave measurements.

Zone A: Fresh Water Wave Tank, Red is the Sonic Wave Sensor RV and Blue is a Wave Staff XB with a 2 meter cable Staff.

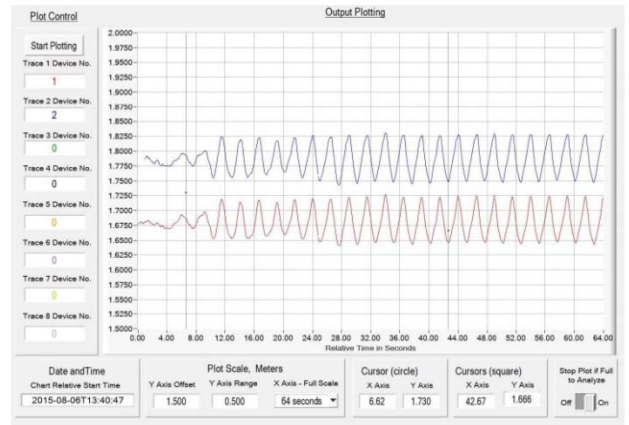
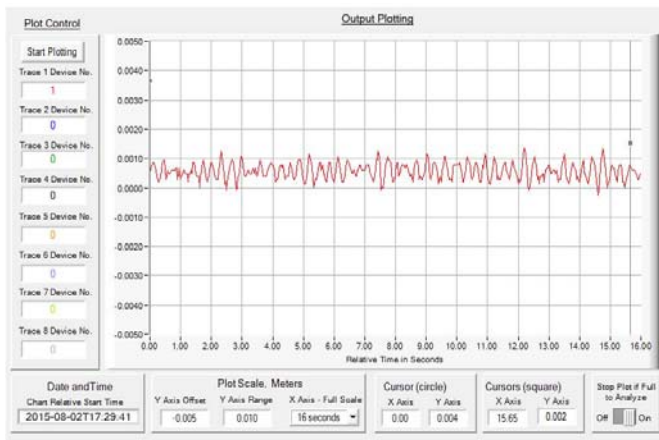

Zone A: Pool waves with high wave steepness

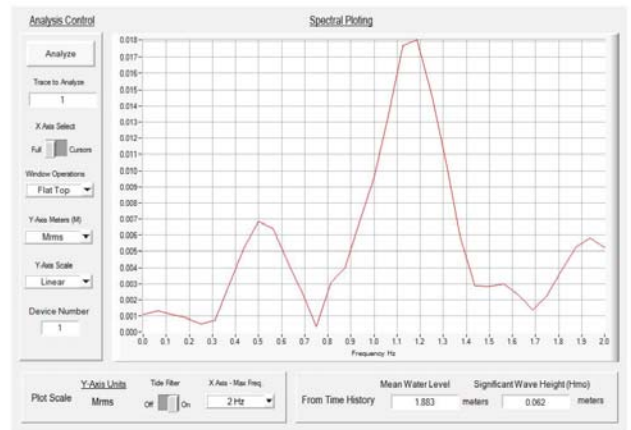
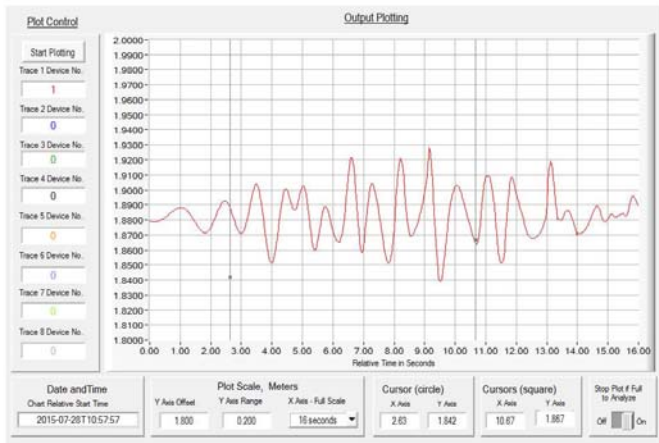

Zone B - Example:

Zone B: Boat Wake on Intracoastal at Dania Beach Florida.

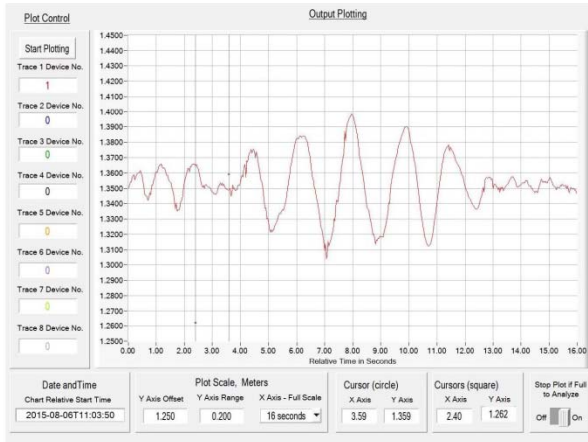

Zone B: Small waves on Intracoastal at Dania Beach Florida.

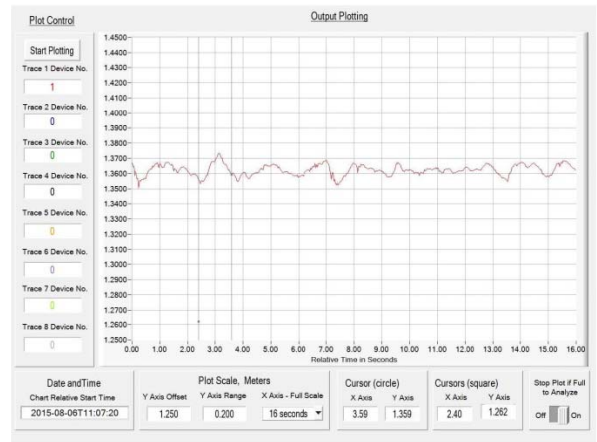

Zone B: Fresh Water Wave Tank, Red is the Sonic Wave Sensor RV and Blue is a Wave Staff XB with a 2 meter cable Staff.

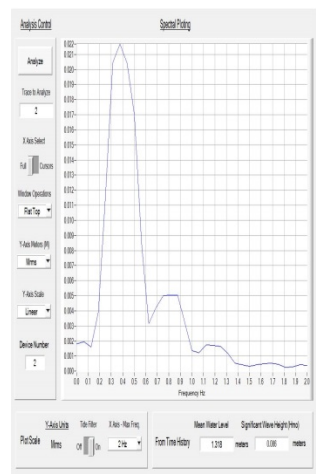
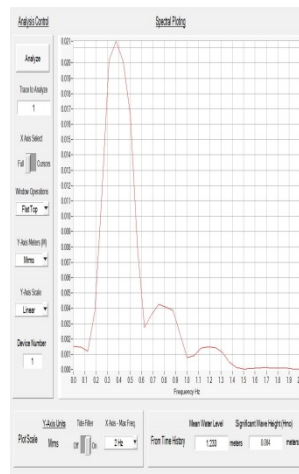
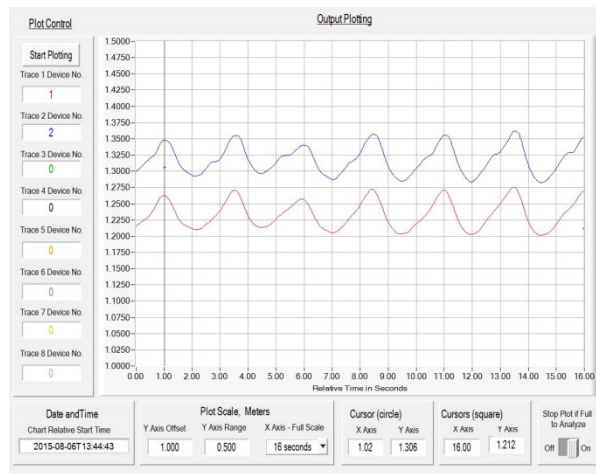

Zone B: Pool Waves with high wave steepness

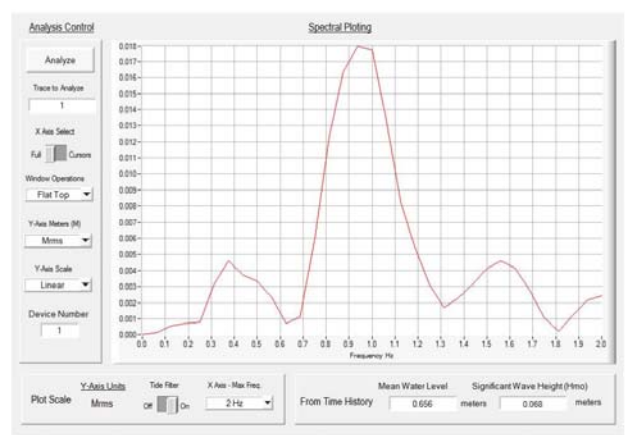
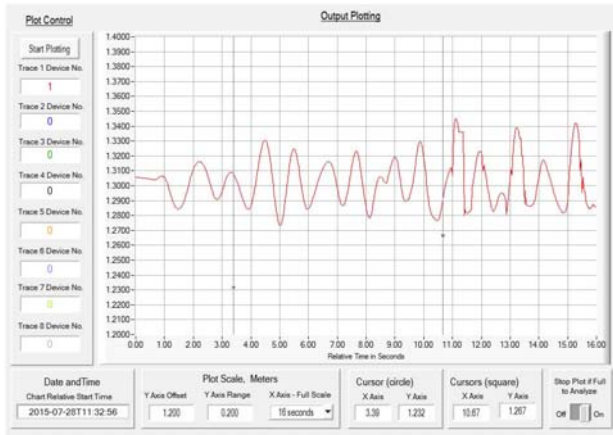

Zone C - Example:

Zone C: Fresh Water Wave Tank, Red is the Sonic Wave Sensor RV and Blue is a Wave Staff XB with 2 meter cable Staff.

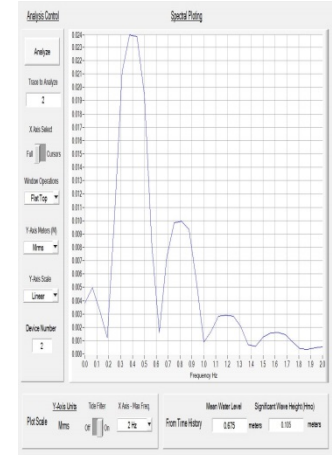
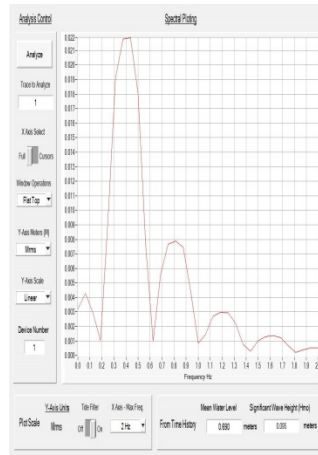
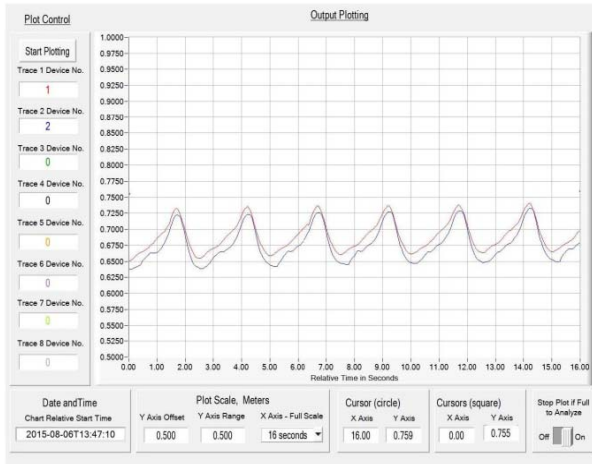

Zone C: Pool Waves with high wave steepness

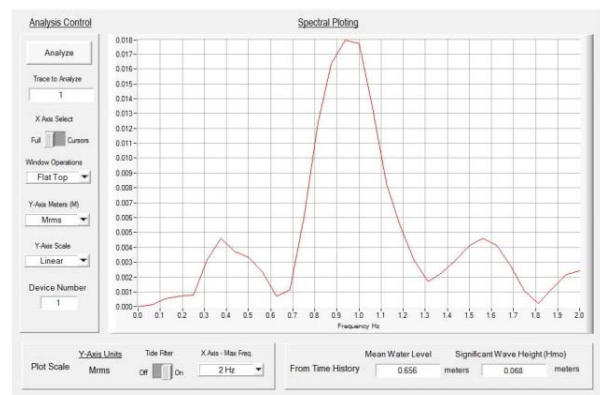
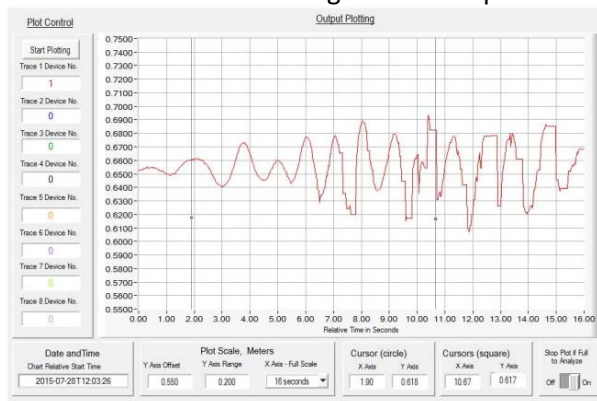

Zone D - Example:

Zone D: Pool Waves with high wave steepness

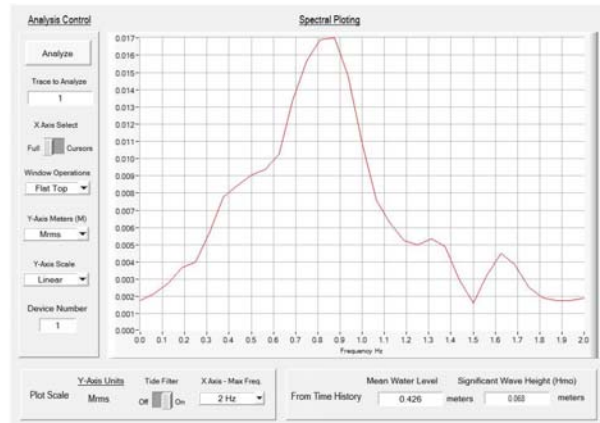
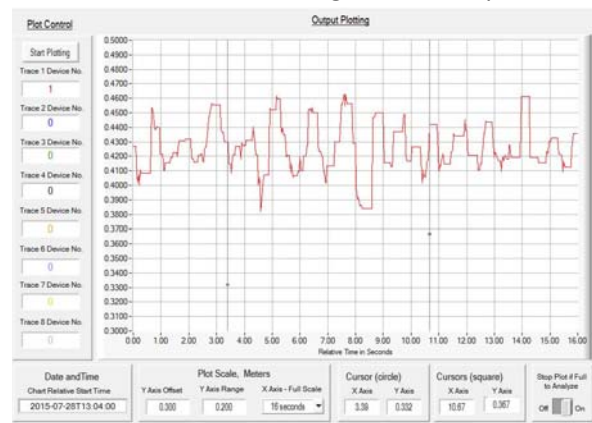

Sonic Wave Sensor RV OSSI-010-036

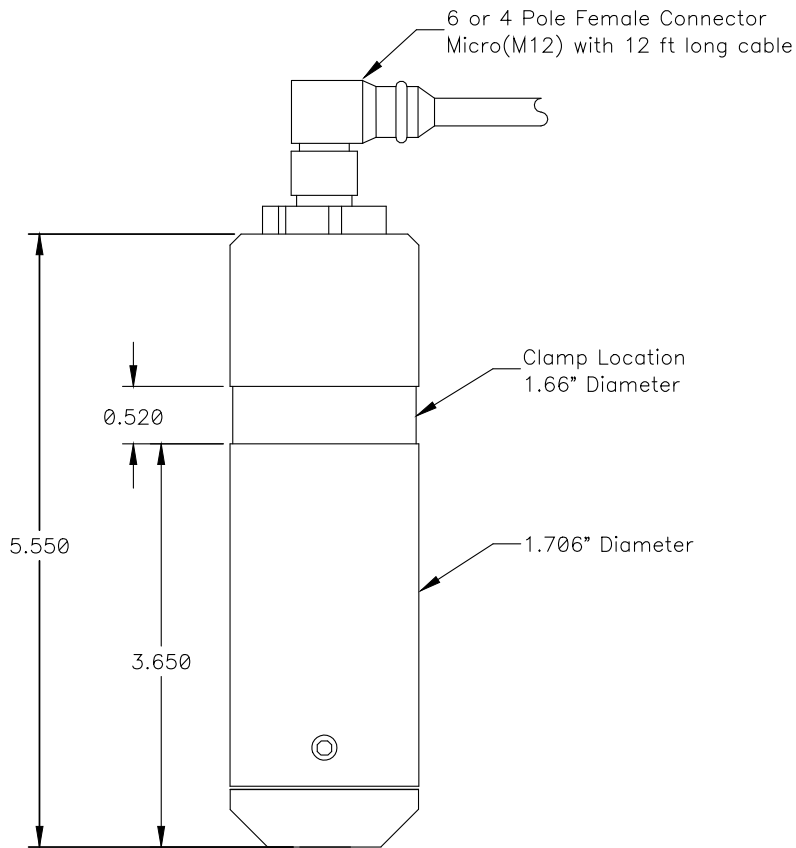

USB Computer Adapters

EasySync USB to RS485 Adapter

USB2-F-5001: USB to RS485 serial Adapter with 5V @ 450mA power out. Part number OSSI-585-003



EasySync USB to RS232 Adapter

USB2-F-1001: USB to RS232 serial Adapter with 5V @ 250mA power out. Part number OSSI-585-002



Mounting Bracket #OSSI-015-018-B

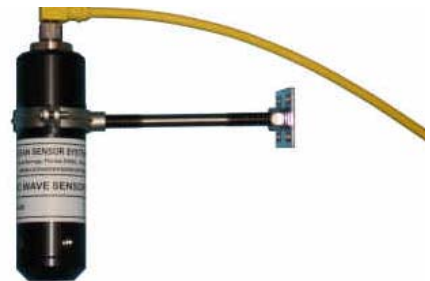

Wire Color code

Part Number	Red	Green	Red/White	Red/black	Red/Yellow	Red/Blue
OSSI-010-036-1 RS485 & 0-5V	+4 to 45V Supply	Power Ground	Data, Positive	Data, Negative	+ 0 to 5V Analog Out	Analog Ground
OSSI-010-036-2 RS232 & 0-5V	+4 to 45V Supply	Power Ground	PC's Receive Data	PC's Transmit Data	+ 0 to 5V Analog Out	Analog Ground

Part Number	Black	White	Blue	Brown
OSSI-010-036-3 RS485	+4 to 45V Supply	Power Ground	Data, Positive	Data, Negative

Sonic Wave Sensor RV Part Numbers:

Part Number	Serial Com	Analog Out	Connector	Calibrated Accuracy
OSSI-010-036-1	RS485	0 to 5V	6 Poles	0.25% FS
OSSI-010-036-2	RS232	0 to 5V	6 Poles	0.25% FS
OSSI-010-036-3	RS485	(None)	4 Poles	0.25% FS
OSSI-010-036-1E	RS485	0 to 5V	6 Poles	0.10% FS
OSSI-010-036-2E	RS232	0 to 5V	6 Poles	0.10% FS
OSSI-010-036-3E	RS485	(none)	4 Poles	0.10% FS

Characteristics:

Parameter	Conditions	Min.	Typ.	Max.	Units
Supply Voltage,		4		45	Volts
Supply Current	1 Hz sample Rate		16		mA
Supply Current	32Hz Sample Rate		25		mA
Data Accuracy	0-100% of Full Scale (1) (6)		0.15	0.25	±% (2)
Data Accuracy, suffix E	0-100% of Full Scale (1) (6)		0.05	0.10	±% (2)
Data Resolution	ASCII 32 Samples (4)		1		mm
	Float 32 Samples (5)		0.1		mm
	Integer 64 Samples (5)		1		mm
	ACCII 1 sample (4)		1		mm
Adjustable Data Range	ASCII 32 Samples (4)	0		99.999	meters
	Float 32 Samples (5)	-99.9999		+99.9999	meters
	Integer 64 Samples (5)	-30		+30	meters
	ACCII 1 sample (4)	0		99.999	meters
Data Linearity			0.15	0.25	± % (2)
Data Linearity, suffix E			0.05	0.10	± % (2)
Data Hysteresis		0.0	0.0	0.0	mm
Sample Frequency		1		32	Hz
Sample Burst Time	Programmable	0		59	minutes
Sample Burst Interval	Programmable	1		60	minutes
Real Time Clock Accuracy	Typical at 25°C		10		PPM (3)
Auto Time Synchronize	Synchronize Time to PC's Clock		0.01		Seconds

Note 1: The unit may need to be calibrated in-situ to meet the Data Accuracy.

Note 2: Percent of Full Scale

Note 3: parts per million

Note 4: Buffered or Continuous output mode.

Note 5: Buffered output mode only

Note 6: Accuracy at 25°C air temperature. Internal temperature sensor compensates for air temperature changes.

Maximum Number of operating units on the same RS485 Network versus Sample Rate and Data Format:

Data Format Output Transmit Mode	Sample Rate Hz					
	1 Hz	2 Hz	4 Hz	8 Hz	16 Hz	32 Hz
ASCII 32 Samples (Buffered)	8	8	8	8	6	3
Float 32 Samples (Buffered)	8	8	8	8	8	4
Integer 64 Samples (Buffered)	8	8	8	8	8	8
ASCII 1 Sample	8	4	2	1	0	0

Supplied Cables with OSSI-036-1 and OSSI-036-2, RS485/RS232 and 0-5V analog:

Connector, M12, 6 Pole, Dual Key, 90 Degrees - Female, Stain Steel, PUR cable 12 feet

OSSI P/N OSSI-515-004, Remke P/N 406C0120AK1

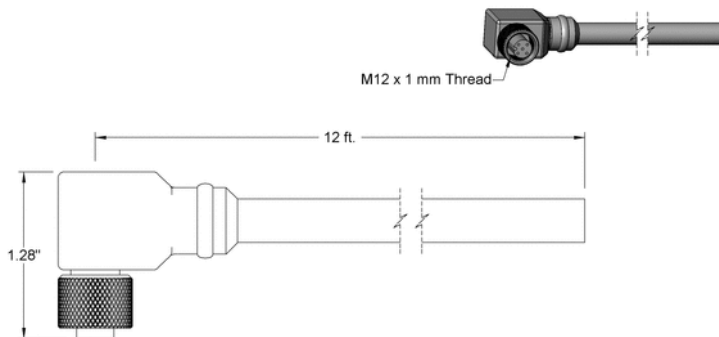

Cables options for OSSI-036-3, RS485 only:

For Single Unit: OSSI P/N OSSI-515-005, Phoenix Contact 1681389, Female R/A, 10 Meter PUR cable



For Daisy Chaining Units:

OSSI part number OSSI-515-006, Phoenix Contact part number 1683002, Female, 10 Meter, PUR cable



For Daisy Chaining Units cont.:

OSSI part number OSSI-515-008, Phoenix Contact part number 1559783, T adapter 4Pole, 2 Female 1 male



OSSI part number OSSI-515-007, Phoenix Contact part number 1509571, Female/Male, 10 Meter, PUR cable



OSSI part number OSSI-150-008 RS485 Terminator 120 ohms



Sensor Calibration Using the Interface Software:

The Sonic Wave Sensor RV's are calibrated at the factory and in most cases they do not need to be re-calibrated. If a different data range, than the factory values, is desired an in-situ re-calibration may be performed.

Multiple Point Sensor Calibration: Up to 12 calibrations points can be set for 0.05% FS accuracy.

1. Plan to place the Sonic Wave Sensor two or more positions from a flat surface. Maximum 12 positions!

Example 1 locations: 20% and 80%

Example 2 locations: 0%, 5%, 25%, 50%, 75%, 95% and 100%.

2. With the Sonic Wave Sensor set at each position set the "Calibrate Meters" value to each position and press the Set button. Each Calibration position will be displayed on the Calibration Points table as they are added.

Sensor Automatic Anti-Aliasing Filter:

When the filter is switched on readings will be taken at a 64 Hz and the reported value will be the average value for the last two configured sample periods. Example: With a configured sample rate of 8Hz the unit will average the last 16 reading at 64Hz and output the value every 125mS. If the filter is disabled one reading will be made per the configured sample rate. The filter response changes automatically with the setting of the Sample Rate. The recommended Sample Rate is 8 or more times the maximum Wave Frequency that will be measured.

Filter Response plot: The Amplitude is normalized to the Wave Height and the Frequency normalized to $1/8^{\text{th}}$ of the Sample Rate. Example if the Sample Rate is set to 8 Hz then the Normalized Wave Frequency is 1 Hz. If the Sample Rate is set to 16 Hz then the Normalized Wave Frequency is 2 Hz.

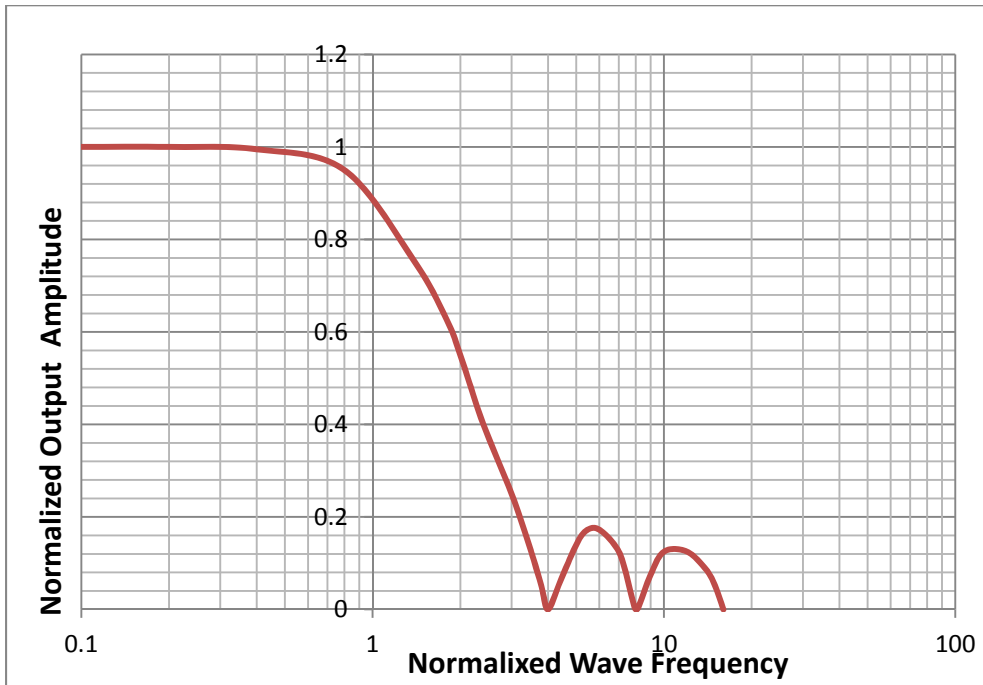

RTC Calibration: (Factory Calibrated)

Method:

1. Determine the Real Time Clock (RTC) error in seconds per minute. (Example .0025 seconds per minute)
2. Calculate the RTC correction value. $(32768 * \text{error})/4 = \text{correction value}$. The value should be negative if the time is fast and positive if the time is slow.
3. Read the current correction value with the Interface Software and add it to the correction value.
4. Enter the new value with the Interface Software.

Example: The clock is 24 second slow every week and the correction value is 7.

$-24 / (60\text{min} * 24\text{hour} * 7\text{days}) = -0.00239$ seconds per minute

$(32768 * -0.00239) / 4 = -19.5 + 7 = -12.5$

Enter the new correction value.

User Interface Software:

A new, easy to use, Sonic and Staff Product Interface Program is available to download from our web site. We recommend using the program to configure the Sonic Wave Sensor RV for your particular requirements. It can also be used to display and analyze wave data. Sampled data can be saved to a file for future analysis with the Interface Software or other analysis software. Up to 8 Sonic Wave Sensors XBs or Wave Staff RVs may be connected to the Interface Program at one time. Right click on any object while running the Interface Program for help.

Output Plotting Tab:

The Output Plotting Tab can be used to plot data from the Sonic Wave Sensor RVs or from a saved file. All data is time tagged and plotted in real time. Vertical Line Cursors can be used to select a portion of the plot for analysis.

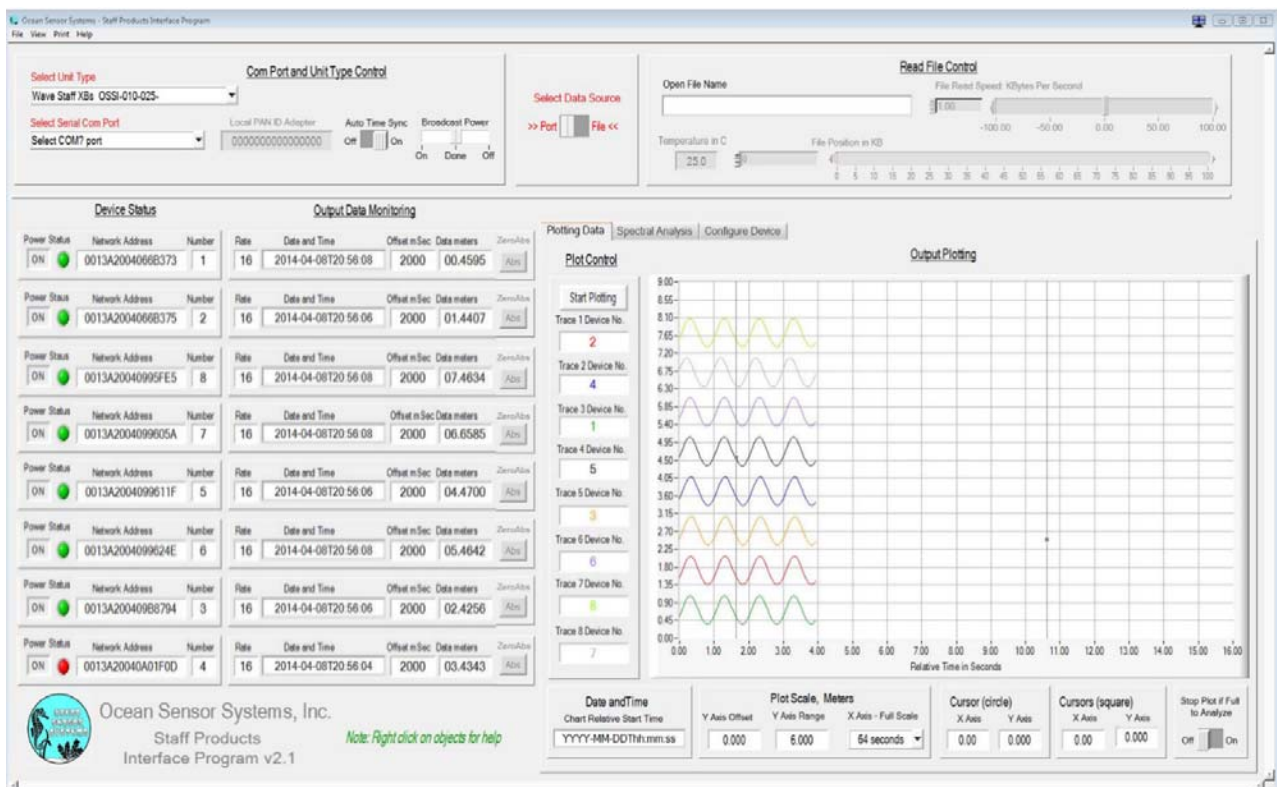

Spectral Analysis Tab:

Plotted Data can be Spectral Analyzed with this tab, with various window operations, data format and scaling. The Mean Water Level and Significant Wave Height are also displayed.

The screenshot displays the 'Spectral Analysis' tab in the 'Ocean Sensor Systems - Wave Staff XB' software. The interface is divided into several functional areas:

- Com Port Control:** Includes a 'Select Serial Com Port' dropdown, a 'Local PAN ID (XSTICK)' field, and buttons for 'Auto Time Sync' and 'Broadcast Power'.
- Read File Control:** Features an 'Open File Name' field, a 'File Read Speed' slider, and a 'Position in KB' slider.
- Wave Staff XB Device:** A table for monitoring multiple devices, with columns for Power Status, Network Address, Number, Rate, Date and Time, Offset in Sec, and Data meters.
- Spectral Plotting:** A graph showing the spectral density of wave data. The Y-axis is 'Y-Axis Meters (M)' ranging from 0.000 to 0.091. The X-axis is 'Frequency Hz' ranging from 0.00 to 1.00. A red line represents the spectral data, showing a prominent peak around 0.25 Hz.
- Analysis Control:** Includes buttons for 'Analyze', 'Trace to Analyze', 'X Axis Select', 'Full Cursors', 'Window Operations' (set to 'Flat Top'), 'Y-Axis Meters (M)' (set to 'Mrms'), 'Y-Axis Scale' (set to 'Linear'), and 'Device Number' (set to '1').
- Summary Metrics:** At the bottom right, it displays 'Y-Axis Units' (Mrms), 'X-Axis - Max Freq' (1 Hz), 'Mean Water Level' (1.693 meters), and 'Significant Wave Height (Hmo)' (0.699 meters).

Configure Device Tab:

Use this tab to select and configure the Sonic Wave Sensor RV for your particular requirements.

The screenshot displays the 'Configure Wave Staff XB' interface. It is divided into several functional areas:

- Com Port Control:** Includes a 'Select Serial Com Port' dropdown (ASRL12 (COM12 - USB Serial Port)), a 'Local PAN ID (XSTCK)' field (0000000111111111), and checkboxes for 'Auto Time Sync', 'Broadcast Power', and 'Done'.
- Read File Control:** Features an 'Open File Name' field, a 'File Read Speed' slider (KBytes Per Second), and a 'Position KBytes' slider (File Position in KB).
- Wave Staff XB Device Table:** A table listing device configurations:

Power Status	Network Address	Number	Rate	Date and Time	Offset mSec	Data meters
ON	0013A2004066B373	1	16	2014-04-08T22:53:02	2000	01.0919
ON	0013A2004066B375	2	16	2014-04-08T22:53:02	2000	01.9770
ON	0013A20040995FE5	8	16	2014-04-08T22:53:00	2000	07.9468
ON	0013A2004099605A	7	16	2014-04-08T22:53:02	2000	06.9384
ON	0013A2004099611F	5	16	2014-04-08T22:53:02	2000	04.9587
ON	0013A2004099624E	6	16	2014-04-08T22:53:00	2000	05.9827
ON	0013A2004099B8794	3	16	2014-04-08T22:53:00	2000	02.9325
ON	0013A20040A01F0D	4	16	2014-04-08T22:52:52	2000	03.9799
- Select Device To Configure:** A section for choosing a device by number (1) or network address (0013A2004066B373?), with a 'Connected' status indicator and a 'Re-Scan' button.
- Changing The Remote PAN:** A section for entering the 'Wave Staff XB PAN ID' (0000000011111111) and a 'Save Remote PAN ID' button.
- Device Information:** Shows 'Device Number' (1), 'Device Part Number' (OSS1-010-027A), 'Serial Number' (13-04-22-001), and 'Version' (01.00).
- Sampling Parameters:** Includes 'Sample Rate' (16 Hz), 'Burst Length' (0), 'Burst Interval' (2), and 'Data Format' (Float 32 Samples).
- Start Time:** A section for setting the start time with fields for Year (2000), Month (1), Day (1), Hour (0), and Minute (1).
- Clock:** A section for setting the current time with fields for Year (2014), Month (4), Day (8), Hour (22), Minute (52), and Second (56), along with a 'RTC Cal Value' field (0).
- Power and Battery:** A section for 'Power' (On) and 'Battery Voltage' (2.94), with a 'Read' button.
- Calibration:** A section for 'Current Mode' (Normal/High), 'Length meters' (1.00), 'Staff Type' (Rod), and 'Calibrate Meters' (1.0000), with 'Factory Values', 'Clear All', and 'Clear' buttons.

The bottom of the interface features the Ocean Sensor Systems logo and the text: 'Ocean Sensor Systems, Inc. Wave Staff XB Interface Program. Note: Right click on objects for help'.

Save Output Data to File:

The format of the data file saved by the Sonic Wave Sensor XB Interface Software is as follows:

The first character of each string defines the data format. The Strings are terminated with a Carriage Return Line Feed.

The first letter defines:

C – ASCII 1 Sample

A - ASCII 32 Samples

F – Float 32 Samples

I - Integer 64 Samples

The ASCII 32 Samples and Float 32 Samples have the same format. The Integer 64 Samples has the same format except for its 64 Samples rather than 32. The value after the first letter is the Device Number followed with a comma. The value after the S is the Sample Rate followed with a comma. (Fixed 2 digit length) The value after the B is the Battery status followed with a comma. (0 = Good Battery, 1 = Low Battery and 2 = Bad battery). The next value is the Date and Time (YYYY-MM-DDThh:mm:ss) that the first sample data in the string was taken. Last is the sampled data. The format is a comma separated ASCII fixed 2.4 length value.

Example - ASCII 32 Samples:

```
A001,S32,B0,2014-03-29T20:46:15,12.9990,...(32).....,15,12.9990\r\n
```

Example - Float 32 Samples:

```
F001,S32,B0,2014-03-29T20:46:15,12.9999,...(32).....,15,12.9999\r\n
```

Example - Integer 64 Samples:

```
I001,S32,B0,2014-03-29T20:46:15,12.9990,...(64).....,15,12.9990\r\n
```

The ASCII 1 Samples format has separate strings for Battery status and Date Time. The value after the D defines the string type followed with a comma. The Date and Time lines are added every 32 samples.

D1 – Sampled Data Example: C001,D1,S08,04.0290\r\n

D8 – Date YYYY-MM-DD Example: C001,D8,2014-03-29\r\n

D9 – Time hh:mm:ss Example: C001,D9,22:26:21\r\n

D7 – Battery Status Example C001,D7,GoodBattery\r\n

The following information is for reference and is not needed when the Sonic & Staff Product Interface Software is used from Ocean Sensor Systems.

There are two types of communication formats used by the Sonic Wave Sensor RV. The OSSI-010-036-1 RS232 ports start with an ASCII format and can be switched to the frame format. The OSSI-010-036-2 and OSSI-010-063-3 RS485 ports use the frame format only.

RS485 Frame Format Communication:

Frame Format Specifications:

Operation - with Escape Characters the data frame structure is defined as follows:

UART Data Frame Structure - with escape control characters:

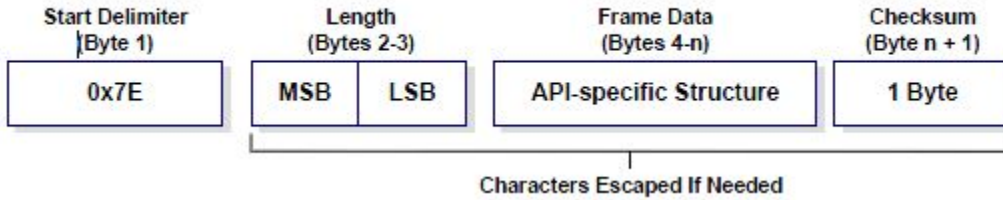

The Frame data of the serial port data frame forms an API-specific structure as follows:

Serial Port Data Frame & API-specific Structure:

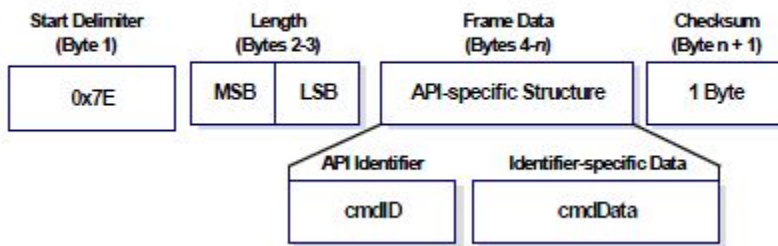

The Following is the Sonic Wave Sensor RV format of the cmdData:

cmdData is the Sonic Wave Sensor RV's data in one of 4 formats (ASCII 1 Sample, ASCII 32 Samples, Float 32 Samples and Integer 64 Samples). The format is the same as the Save Output Data file by the Staff Product Interface Software except for the sample data. The Sample data is as follows: ASCII 32 Samples: Data Format ASCII characters 0 thru 9 (0 to 9999 millimeter) with a resolution of 1.0 millimeter. Float 32 Samples: Data Format Binary Float (4 bytes) with a resolution of 0.1 millimeter. Integer 64 Samples: Data Format 16 bit unsigned integer (0 to 19999 millimeter) with a resolution of 1.0 millimeter.

RS232 Adapter Communication format:

On power up the Sonic Wave Sensor RV will be in the ASCII text mode. The format will be switched, when connected to the Sonic & Staff Product Interface Program, to the framed format.

The Command Set for ASCII text mode and framed comData:

Enter help to see the command list

To read configuration values:

Enter RH to read the Part number

Enter RK to read the Software version

Enter RD to read the Serial number

Enter RX to read the Device Number (1 to 255)
Enter RS to read the Sample Rate
Enter RL to read the Burst Length
Enter RI to read the Burst Interval
Enter RF to read Filter Enable Status (1=yes 2=no)
Enter RR to read Start Time Enable Status (1=yes 2=no)
Enter RT to read the Time and Date (YY-MM-DDThh:mm:ssZ)
Enter RQ to read the Start Time and Date minus 1 minute (YY-MM-DDThh:mmZ)
Enter RV to read the Battery Voltage
Enter RM to read Output Local Enable Status (1=yes 2=no)
Enter RN to read Output XBee Enable Status (1=yes 2=no)
Enter RZ to read Time & Date Sync to Second (YY-MM-DDThh:mm:ssZ)
Enter RB to Read latest Sensor data
Enter RO to read Output Data Format (1=ASCII, 2=Binary float, 3=Binary Int & 4=Continuous ASCII)
Enter RJ to read Output Offset Count (0 to 1023) 7.8125mS per count
Enter RP to read Power State (1=on & 2=off)
Enter RC to read the RTC Cal clock per Min. (-127 to 128)

To write new configuration values:

Enter WZ,? to Enable/Disable Text Interface(1=on & 2=off)\
Enter WS,?? to write the Sample Rate (1,2,4,8,16 or 32 Hz)
Enter WL,?? to write the Burst Length (1 to 59 Minutes, 0 for Continuous)
Enter WI,?? to write the Burst Interval (1 to 60 Minutes)
Enter WF,??? to write Filter enabled (1=yes & 2=no)\r\n"
Enter WX,?? to write new Device Address Number(1 to 255)
Enter WR,? to write Start Time enabled (1=yes & 2=no)
Enter WT,YY-MM-DDThh:mm:ss to write New Time and Date
Enter WQ,YY-MM-DDThh:mm to write New Start Time and Date
Enter WO,? to write Output Data Format (1=ASCII, 2=Binary float, 3=Binary Int & 4=Continuous ASCII)
Enter WC,??? to write the RTC Cal clock per Min.(-127 to 128)

To read Calibrate values:

Enter GT to Get Sensor Type (1 = Rod, 2= cable, 3 = sonic)
Enter GS to Get the Sensor range in meters
Enter GA to Get All calibration points

To Set the Calibrate values:

Enter FT,??,??? to Set sensor Type <Ref only> (1 = Rod, 2= cable, 3 = sonic)
Enter FS,??,??? to Set Sensor Range in meters <Ref only> (0.500 to 2.5)
Enter FP,? to Set a Low current calibration point <Ref only>
Enter FN,? to Clear a Low current calibration point <Ref only>
Enter FC,1 to Clear all Low current calibration points <Ref only>
Enter FF,1 to restore the factory calibration value

Other Commands:

Enter OA,? to write Output Format Type(1=ASCII, 2=Framed)